

# Dryer

M720 Programming and Operation Manual

February 1, 2011

Revision 1.3

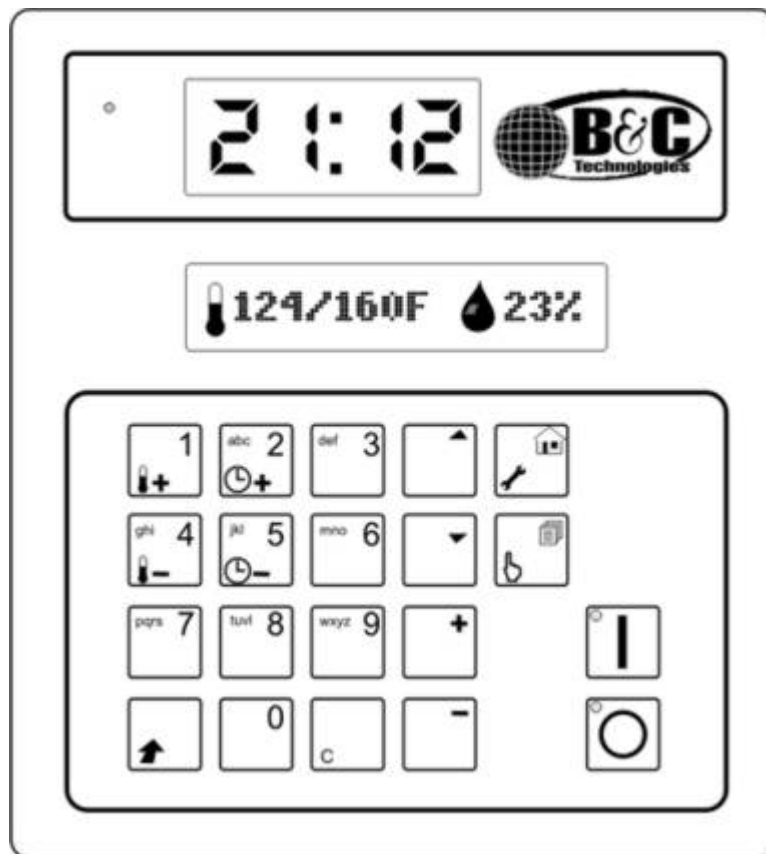

# Contents

- 1 Important Safety Information 1**
  - 1.1 FOR YOUR SAFETY - CAUTION! . . . . . 1
  
- 2 Control Overview 2**
  - 2.1 Features . . . . . 2
  - 2.2 Display and Keypad Functions . . . . . 3
  
- 3 Operation 10**
  - 3.1 Selecting a Drying Program . . . . . 10
    - 3.1.1 Selecting an adjusted program . . . . . 10
    - 3.1.2 Single Cycle Mode . . . . . 11
    - 3.1.3 Starting a Cycle . . . . . 11
    - 3.1.4 Program Operation . . . . . 12
    - 3.1.5 Program Completion . . . . . 12
  - 3.2 Display Overview . . . . . 12
    - 3.2.1 Status Line with Temperature . . . . . 13
    - 3.2.2 Status Line with Humidity Sensor . . . . . 14
    - 3.2.3 Status Line with Times . . . . . 14
    - 3.2.4 Numeric Display . . . . . 14
    - 3.2.5 LED Functions . . . . . 15
  
- 4 Programming 16**
  - 4.1 Menu Structure . . . . . 16
  - 4.2 Entering a Password . . . . . 16

4.3	Delayed Start . . . . .	18
4.4	Counter Menu . . . . .	18
4.4.1	Counters per Program . . . . .	19
4.4.2	Counters per Day . . . . .	19
4.4.3	Counters in Total . . . . .	20
4.4.4	Non-resettable Counters . . . . .	20
4.5	Edit Parameter Menu . . . . .	21
4.5.1	Edit Program Parameters . . . . .	21
4.5.2	Edit Program Name . . . . .	25
4.5.3	Edit Machine Parameters . . . . .	26
4.6	Test Program Menu . . . . .	31
4.6.1	View Status of Inputs . . . . .	31
4.6.2	View Status of Outputs . . . . .	32
4.6.3	Test Outputs Manually . . . . .	32
4.6.4	Check Power Supply Voltage . . . . .	32
4.7	System Setup Menu . . . . .	33
4.7.1	Adjust Date and Time . . . . .	33
4.7.2	Change Language . . . . .	33
4.7.3	Restore Factory Settings . . . . .	34
4.7.4	Reset Maintenance Request . . . . .	34
4.7.5	Enter Unlocking Code . . . . .	34
4.8	Alarm History . . . . .	35
4.9	Edit Machine Configuration . . . . .	35
4.10	Controller Information . . . . .	37
<b>5</b>	<b>Alarms</b>	<b>39</b>
<b>6</b>	<b>Default Settings and Default Programs</b>	<b>43</b>
6.1	Default Values . . . . .	43

# Chapter 1

## Important Safety Information

### 1.1 FOR YOUR SAFETY - CAUTION!

**WARNING:** For your safety the information in this manual must be followed to minimize the risk of fire or explosion or to prevent property damage, personal injury or death.

- Do not store or use gasoline or other flammable vapors and liquids in the vicinity of this or any other appliance.
- WHAT TO DO IF YOU SMELL GAS:
  - Do not try to light any appliance
  - Do not touch any electrical switch; do not use any phone in your building.
  - Clear the room, building or area of all occupants.
  - Immediately call your gas supplier from a neighbors phone. Follow the gas suppliers instructions.
  - If you cannot reach your gas supplier, call the fire department.
- Installation and service must be performed by a qualified installer, service agency or the gas supplier.

**Contact your local gas supplier to obtain particular instructions in the event that a user smells gas. Place this sheet and any other instructions obtained from your gas supplier in a prominent location.**

# Chapter 2

## Control Overview

The M720 is a user configurable microprocessor controller used to control dryers. Because of the versatility of the software, it can be used in almost any type of dryer, without the need to modify the software.

### 2.1 Features

The controller has the following features:

- 192 x 32 pixels display.
- 3 large 7-segment displays to indicate estimated time left and alarms.
- 20 buttons with cap-sense technology. These buttons work with capacitive measurement, with no moving parts which increases reliability.
- 100 different drying programs, each with its own name of up to 32 characters to indicate the type of program.
- 16 digital optically isolated inputs.
- 8 digital relay outputs, up to 250VAC, 8A.
- 2 probes for temperature measurement.
- 1 analog output for controlling the cylinder speed in cases where an inverter is used.
- Optional automatic drying with optional humidity sensor.
- Up to 8 extension boards, each with 8 inputs and outputs can be used to extend the number of inputs and outputs if required.
- RS485 communication port for communication with PC for transferring parameters, translations, character sets, etc.

- Power supply monitoring.
- Full worldwide character set, including Chinese, Japanese, Thai, Russian, Arabic and Greek characters.
- Stores up to 50 different languages.
- No parameter settings will be lost in case of power supply failure or battery.
- Self-configurable start-up logo, which can be used to customize the controller.
- Edit and add languages with the use of free software.
- Extended test programs which allow the user to monitor and control each input/output individually.
- Counters per program, total counters and counters per day. The production data of the last 50 days is stored.
- Alarm history which records the last 50 alarms and messages, this history is battery backed up so service engineers can track malfunctions even if the controller has been switched off.

## 2.2 Display and Keypad Functions

### 1. Numeric display

A large display which can be read from longer distance. Is used to display current alarm number and estimated cycle time remaining. See Section 3.2.4.

### 2. Graphical display

The display which is used to display detailed messages, displaying parameter values, counters, etc.

### 3. HOME and SETUP key

This key can be used in any screen to return to the overview screen. If the overview screen is active and this key is pressed in combination with the Shift key (see item 10), the main menu is activated. The main menu gives access to controller functions like reading and resetting counters, adjusting parameters and running test programs. See 4.1 for an explanation of the possibilities in the main menu.

### 4. SELECT PROGRAM key

If this key is pressed in the main screen, another drying program can be selected (see Section 3.1.1). If the overview screen is active and this key is pressed in combination with the Shift key (see item 10), a single cycle program can be entered (see Section 3.1.2)

**Note:**

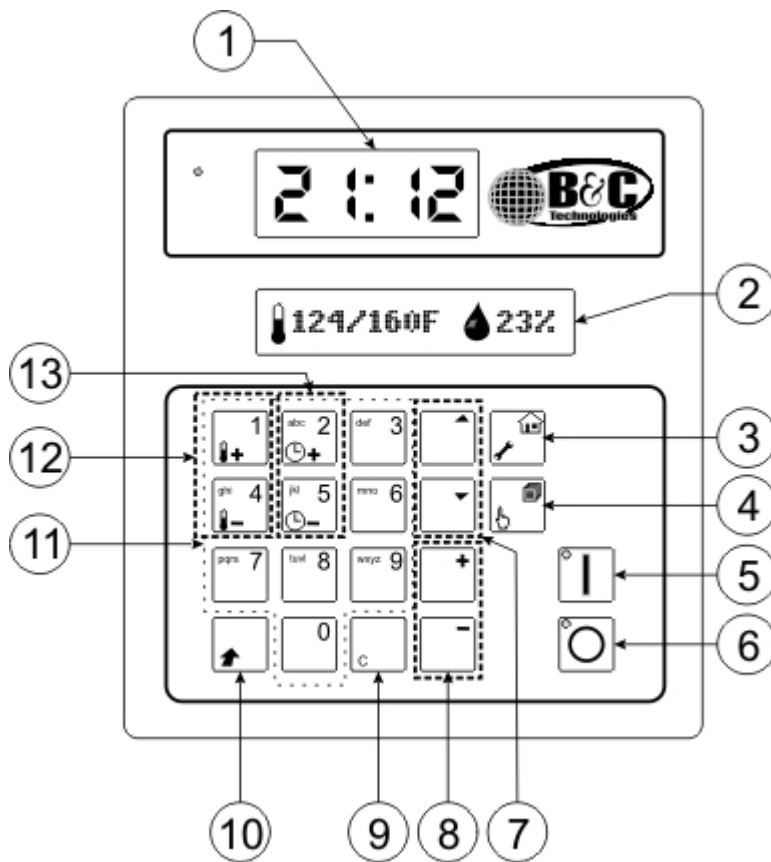

Figure 2.1: M720 Display and Keypad Detail

A pre-defined drying program or a single cycle program can only be chosen if there is no active drying cycle, a cool-down cycle or when a program is finished but there is still a batch inside the machine. In practice this means that this key only works if the machine is in the ready to start state.

#### 5. **START key**



This key is used to (re)start the machine and to reset alarm messages. If an alarm is active, and the cause of the alarm has been solved, the alarm can be reset by pushing this key. This key is also used to start the machine after selecting a program (see Section 3.1.3) or to restart the machine after a temporary stop (see Section 3.1.4).

#### 6. **STOP key**

This key is used to stop a program cycle. If the machine is running a cycle and this key is pressed once, the dryer will stop and the message WAITING FOR CYCLE RESTART will be displayed. If the START key is pressed in this situation (see item 5), the cycle will restart. If the STOP key is pressed once again, the current program cycle will be interrupted and the machine will go back to the ready to start situation again and a complete new program cycle can be started.



The STOP key is also used to silence the beeper in case of an alarm. When an alarm is activated the beeper will beep once every second. To silence the beeper while working on the machine to solve the cause of the alarm, push the STOP key once.

#### 7. **UP ARROW and DOWN ARROW buttons**

These buttons can be used to scroll through a list of, for example, menu-items. If the buttons can be used in a screen, this will be indicated with an icon. If a list is in the screen, and it is possible to move up and down in the list, the  icon will be displayed. If it is only possible to use the DOWN ARROW key (for example, when the current item is the first item in the list), the  icon will be displayed. If it is only possible to use the UP ARROW key (for example, when the current item is the last item in the list), the  icon will be displayed.

In many cases these buttons can also be used in combination with the SHIFT key (see item 10). If the arrow buttons are used in combination with this key, the selection will move to the first or last item instead of moving to the next or previous item.

#### 8. **PLUS and MINUS buttons**

These buttons can be used to increase or decrease an adjustable value. If the buttons can be used in a screen, this will be indicated with an icon. If a value is in the screen, and it is possible to use both the PLUS and MINUS buttons, the  icon will be displayed. If it is only possible to use the PLUS key (for example when a value has reached the maximum allowed limit), the  icon will be displayed. If it is only possible to use the MINUS key (for example when a value has reached the minimum allowed limit), the  icon will be displayed.

In many cases these buttons can also be used in combination with the SHIFT key (see item 10). If the PLUS and MINUS buttons are used in combination with this key, a value will increase or decrease with a higher value instead of 1.

#### 9. **ENTER and CLEAR key**

Pushing the ENTER key without the SHIFT key (see item 10) means enter or accept. If the key is pressed in combination with the SHIFT key (see item 10), it becomes the CLEAR function.

The ENTER key is used to confirm a choice or an adjustment. For example, if another program is selected from the list, the ENTER key must be pressed to confirm the choice. This is the same when a parameter value is changed. When a new value is entered, this value must be confirmed with the ENTER key, otherwise the change in value will not be stored.

The CLEAR key is used to cancel an entered value. For example, when a parameter has been changed in error, pressing the CLEAR key cancels the change. If the ENTER key is pressed in combination with the SHIFT key, the old parameter value will be restored.

#### 10. **SHIFT key**

This key is used to access the secondary function of a key. When a key is pressed without the SHIFT key, it functions normally, as indicated in white on the key. If a key is pressed in combination with the SHIFT key, the secondary function is activated, indicated by function in the same color as the SHIFT key. To use the secondary function of a key, first push the SHIFT key, then push the key itself while holding the SHIFT key. Release the key then release the SHIFT key.

#### 11. **Numeric keypad**

These buttons can be used to enter a numeric value. For example in the program selection screen a program number can be entered with these buttons. Entering a new parameter value and entering a password can also be done with these buttons.

The numeric keypad buttons are also used for editing the name of a program. In this case they are used to enter characters (see Section 4.5.2 on page 25).

#### 12. **Temporary temperature set-point change**

Sometimes it is necessary to manually adjust the temperature to a higher or lower set-point. If the SHIFT key (see item 10) is pressed in combination with the INCREASE TEMPERATURE (▲) key, the current temperature set-point will be increased by 5 degrees Fahrenheit (or 2.8 degrees Celsius). If the SHIFT key (see item 10) is pressed in combination with the DECREASE TEMPERATURE key (▼), the current temperature set-point will be decreased by 5 degrees Fahrenheit (or 2.8 degrees Celsius). The controller uses Fahrenheit units internally but the interface units are configurable as either Fahrenheit or Celsius. When the interface temperature units is set to Fahrenheit increments of 5 degrees increase or decrease will be displayed. When the interface temperature units is set to Celsius the display will sometimes show an increment of 2 degrees and sometimes an increment of 3 degrees. This is because 5 degrees Fahrenheit is equal to 2.8 degrees Celsius but DOES NOT influence the actual increment, which is always 5 degrees Fahrenheit.

Please note that these changes in set-point are temporary. They do not change the programmed value in the active program. This means that the next time the program runs, the temporarily changed values will be forgotten. Also, if a temporary change is made in the drying cycle of the program, this does not influence the cool-down temperature setting adjusted.

#### 13. **Temporary time change**

When a drying or cool-down cycle is active, the adjusted drying or cool-down time is set at the moment the drying or cool-down cycle starts. Sometimes it is necessary to manually adjust the time to a higher or lower value. This can be done with these buttons in combination with the SHIFT key (see item 10). If the SHIFT key (see item 10) is pressed in combination with the INCREASE CYCLE TIME key (⌚+), the current time remaining in the drying or cool-down cycle will be increased by 5 minutes. If the SHIFT key (see item 10) is pressed in combination with the DECREASE CYCLE TIME (⌚-) key, the current time remaining in the drying or cool-down cycle will be decreased by 5 minutes. Please note that these changes in time are temporary. They do not change the programmed value in the active program. Also, if a temporary change is made in the drying cycle of the program, this does not influence the cool-down time setting programmed.

Table 2.1: Special key Functions





















	Item	Normal Function	Shift Function
	5	START	-
	6	STOP	-
	10	SHIFT	-
	9	ENTER	CLEAR
	4	Select Program	Single Cycle
	3	HOME	SETUP
	7	ARROW UP (move to previous item)	Move to 1st item in parameter list
	7	ARROW DOWN (move to next item)	move to last item in parameter list
	8	PLUS (Increase single step)	PLUS (increase multiple steps)
	8	MINUS (Decrease single step)	MINUS (decrease multiple steps)
	12	1 / alphanumeric special characters	Increase Temperature setpoint
	12	4 / alphanumeric	Decrease Temperature setpoint
	13	2 / alphanumeric	Increase cycle time
	13	5 / alphanumeric	Decrease cycle time

Table 2.2: Display Symbols

Icon	Description
	Primary Temperature Sensor
	Secondary Temperature Sensor
	Infra Red Temperature Sensor
	Humidity Sensing
	Drying Time
	Cooling Time

# Chapter 3

## Operation

The basic operation of the machine consists of the following steps:

1. Select a drying program
2. Starting the program
3. Program running
4. Program completed

### 3.1 Selecting a Drying Program

Before a drying program is started, the user must make sure that the correct drying program is selected. The drying program is displayed in the upper line of the overview screen (see Chapter 4 on page 16).

If the correct program is not selected (for example, a drying program for towels is selected, but the current machine load is a batch of sheets), the user must select another program. If the correct program has been selected, step 2 can be done (see Section 3.1.3 on page 11).

For choosing a program, there are 2 possibilities. If a predefined program can be used, Section 3.1.1 on page 10 is applicable. It is also possible to manually configure a single cycle program. This can be used in cases where there is no suitable predefined program, for example if a batch is already partially dry, or in case of special material which is not normally done with this machine. In case a single cycle program is necessary see Section 3.1.2 on page 11.

#### 3.1.1 Selecting an adjusted program

From the overview screen, the user can go to the program selection screen by pushing the SELECT PROGRAM key, or by directly entering the program number via the numeric keypad.

In this screen, a predefined program can be selected with the numeric buttons 0 to 9 or with the ARROW UP and the ARROW DOWN buttons. The currently selected program number, together with the program name is displayed in the lower line of the display. If the arrow buttons are used in combination with the SHIFT key, the selected program will be increased or decreased by 10.

When the correct program has been selected, confirm by pressing the ENTER key. When this key is pressed, the selected program will be activated and the overview screen is displayed again. When this has been done the cycle can be started.

It is also possible to use the START key. If this key is used, the current selected drying program will be chosen, the drying program will be started immediately and the main screen is activated again. This means that cycle start as described in section 3.1.3 on page 11 is executed immediately. If no alarms are active, go to section 3.1.4.

### **3.1.2 Single Cycle Mode**

This mode is used in special circumstances like partially dried batches and special materials. If the SELECT PROGRAM key is used in combination with the SHIFT key, the screen for entering a single cycle is displayed. In the single cycle screen, a self chosen drying time and temperature can be entered. By default, the values are as defined in program 50 and these values can then be programmed by the user.

The screen will start up with the edit-field on the drying time. If necessary change the drying time value with the PLUS or MINUS buttons or with the NUMERIC buttons and confirm with the ENTER key. When the ENTER key is pressed, the cursor will move to the drying temperature. Change the value if necessary in the same way and confirm with the ENTER key. When the ENTER key is pressed while the cursor is on the drying temperature, the overview screen is activated again, and the cycle is ready to be activated (see section 3.1.3 on page 11).

In the screen for entering a single cycle drying time and temperature, the cursor can be moved to the next or previous edit-field with the ARROW UP and ARROW DOWN buttons.

When a single cycle program is finished, the controller will automatically switch back to the predefined program which was last used before the single cycle was started.

### **3.1.3 Starting a Cycle**

After the correct program has been selected, a program cycle can be started with the START key. If this key is pressed, the software will check if all inputs are in the correct state. If so, the cycle is started and step 3 is activated (see section 3.1.4 on page 12). If one of the inputs is not in the correct state, the lower line in the display will show an alarm text and the numeric display above the graphical display will start blinking with the alarm number. A full explanation of the available alarms and their cause can be found in Chapter 5 on page 39.

### 3.1.4 Program Operation

In this phase the program cycle is running. A program cycle can be a drying step, a cool-down step or both. When running, the 2<sup>nd</sup> line in the overview screen will show the current status (see Chapter 4 on page 16).

If an alarm occurs, the machine will be stopped by the controller and the program cycle will be paused. The same will happen if the STOP key is pressed.

When cause of the alarm has been corrected, the alarm can be reset with the START key. After that, Waiting for cycle restart will be displayed. The same will happen if the STOP key is pressed once.

If the message Waiting for cycle restart is displayed, the cycle can be restarted with the START key and the pause situation is canceled. If, in this case, the STOP key is pressed, the complete program will be canceled and the step described in section 3.1 on page 10 is activated.

When the drying step and the cool-down step are finished, the step described in section 3.1.5 on page 12 is activated.

### 3.1.5 Program Completion

This step is activated when a program cycle is finished. When the program cycle is completed, the beeper will sound for the time defined in machine parameter 6 (see Section 4.5.3 on page 26). This beeper sound will restart every 2 minutes.

After finishing a program the machine will either stop or the anti-crease cycle will start if selected. The anti-crease function can be enabled or disabled in the program parameters (see Section 4.5.1 on page 21).

If anti-crease is enabled the machine will be stopped for 2 minutes after finishing a program cycle. 2 minutes later, anti-crease function starts. This means that the drum direction and speed as defined in the program will be used and the blower will be off.

Note: Because the blower output is off during anti-crease operation, the anti-crease function will not work if the blower and the drum motor are both connected to output 7 during installation of the controller.

If a cycle is completed, the dryer will stay in this step (audible signal and/or anti-crease operation) until the door is opened. When the door is opened, the controller assumes the dryer will be emptied and will go back to the ready to start state as described in Section 3 on page 10.

## 3.2 Display Overview

During normal operation, the display will show the overview screen. In this screen, the currently selected program number and name is displayed in the upper line. The lower line is used to display the current state of the machine. In case an alarm is active, the alarm text will be shown

on the lower display. If the machine is running, the lower line is used to display temperatures and time left to finish cycle.



Before starting the machine, the overview screen may look like:

## 1 : Program name Ready to start

The screen indicates that program number 1 is selected and that the machine is ready to start. If the START key is pressed, the software will check if all inputs are in the right state. If all inputs are ok, the cycle is started and the message READY TO START will be replaced by the current status of the drying program. The machine will start a drying cycle. If a cycle is running, the lower line can display 2 different lines:

 24 / 75 °C Drying

or



 30m  +  40m

Which line is displayed depends on the setting in machine parameter 7 (see Section 4.5.3 on page 26). This parameter is used to adjust whether the status line should only indicate the temperature, only the times, or if the status line should toggle between temperature and time.

### 3.2.1 Status Line with Temperature

As explained above, the status line with temperature may look like:

 24 / 75 °C Drying

The  symbol means that heating is active. The machine is warming up to reach or maintain the programmed temperature. If the software temperature controller decides that heating should be off, the + symbol will disappear and the  symbol will be replaced by a  symbol, indicating that the heater output is off. If the heater output is on, the yellow LED at the upper left of the control will also be on (see Section 3.2.5 on page 15).

The 24 / 75 °C string indicates the current temperature and goal temperature. In this example, the current temperature is 24 °C and the goal temperature is 75 °C. In this example the temperature is displayed in degrees Celsius. It is also possible to use Fahrenheit units. This is adjustable with machine parameter 1 (see Section 4.5.3 on page 26).

The last text in the line indicates which step in the drying cycle is active. In this example, the drying step is active. When the drying step is completed the dryer will switch to cool-down mode, and the text DRYING will be replaced by COOLING DOWN.

If the machine is operating with automatic drying with a double temperature sensor, an infra-red

sensor or a humidity sensor, the text DRYING will be toggled with the current automatic drying value. Automatic drying means that the current drying method in the program parameters is set to AUTO. If so, the controller will continuously check if the current batch is dry. To determine this, it will use a second temperature sensor, an infra-red sensor or a humidity sensor, whichever one is available.

### 3.2.2 Status Line with Humidity Sensor

If a humidity sensor is present (and set in the machine configuration), the humidity sensor is placed in the exhaust. It can then measure the humidity of the outlet air to detect if the batch is dry. Program parameter 10 is used to determine if the batch is dry. If a humidity sensor is present, the 2<sup>nd</sup> line may look like:



 24 / 75 °C  23%



The value on the right is the current measured air humidity by the humidity sensor. If the value is measured below the programmed value for long enough, the batch is considered to be dried.

### 3.2.3 Status Line with Times

As explained, the status line with times may look like this:

 30m  +  40m

The  symbol indicates that the drying step is active. The estimated remaining time for drying is 30 minutes. If the cool-down step is active, the  symbol will be replaced by the  symbol.

The  +  symbol is a symbol for the total time remaining. The total time remaining is the estimated remaining drying time plus the estimated remaining cool-down time. In this example, the total estimated time left is 40 minutes. From this we can also derive that the estimated remaining cool-down time is 10 minutes. Because the estimated remaining drying time is 30 minutes and the estimated remaining total time is 40 minutes, the estimated remaining cool-down time is 40 - 30 = 10 minutes.

### 3.2.4 Numeric Display

Just above the graphical display, there are three 7-segment displays. These 7-segment displays can only be used to display numbers and some simplified symbols. The 7-segment displays will be referred to as the numeric display.

The numeric display is larger than the graphical display, which means that it can be read from further away. It is used to indicate the current alarm number, the estimated total cycle time left

and to notify the user that a program is finished and that the batch is ready to be taken out.

If an alarm is active, the numeric display will toggle between - - - and the current alarm number. In this case the lower line of the graphical display will show the alarm text corresponding with the alarm number. For a full explanation of all available alarms, see Chapter 5 on page 39.

If a drying or cool-down cycle is running, the numeric display will show the estimated time left for the cycle in minutes.

If the program has finished the numeric display will toggle between - - - and empty. This indicates that the drying and cool-down has been done and that the batch is ready to be taken out of the dryer.

When the machine is not drying or has finished a program, and no alarms are active, the numeric display will only show - - -.

### 3.2.5 LED Functions

The controller has 3 LEDs: A yellow LED next to the numeric display at the top left of the display, a red LED within the stop key and a green LED within the start key.

The yellow LED indicates the status of the heating output. If the LED is on, the call for heat output is on, and when it is off, the call for heat output is off.

The red and green LEDs are used to indicate the current machine status. See Table 3.1 on page 15 for details.

Table 3.1: LED Functions

Red LED	Green LED	Meaning
On	Blinking	A warning or alarm is active. The upper numeric display will toggle between — and the alarm number. See Chapter 5 on page 39 for the available alarms.
Blinking	Blinking	A program cycle is finished and the controller is waiting for the goods to be taken out of the machine. The upper numeric display will toggle between — and empty.
On	Off	The stop key was pressed during a running cycle. If the STOP key is pressed again the cycle will be canceled and the machine will return to the ready to use state. If the START key is pressed, the program will resume.
Off	Blinking	The machine is ready to start. If the START key is pressed, the program will begin.
Off	Off	Program cycle running

# Chapter 4

## Programming

### 4.1 Menu Structure

If a parameter setting needs to be changed, a counter needs to be read or reset or test programs need to be run, these items can all be accessed via the main menu.

The main menu can be accessed by pushing the set-up key in the main screen. The set-up key is the SHIFT key in combination with the HOME key.



Press the SHIFT and HOME key combination and the main menu will be displayed. Items can be selected from the menu by using the ARROW UP and/or ARROW DOWN key. Confirming the choice of an item is done by pressing the ENTER key. Some items give direct access to functions, some items will open another menu. The menu tree is shown in Figure 4.1 on page 17.

### 4.2 Entering a Password

To gain access to some of the menu items mentioned above, a password is necessary. The controller will not ask for a password unless it is needed to approve access to a menu item. If an item is password protected the password screen will be activated and the controller will prompt to enter a password. See Table 4.1 on page 18 for details.

If a password is entered, it will remain valid for 10 minutes. If no action which requires a password is undertaken for 10 minutes, the password must be entered again.

A special password (1111) is available for resetting the maintenance request (see Section 4.7.4 on page 34)

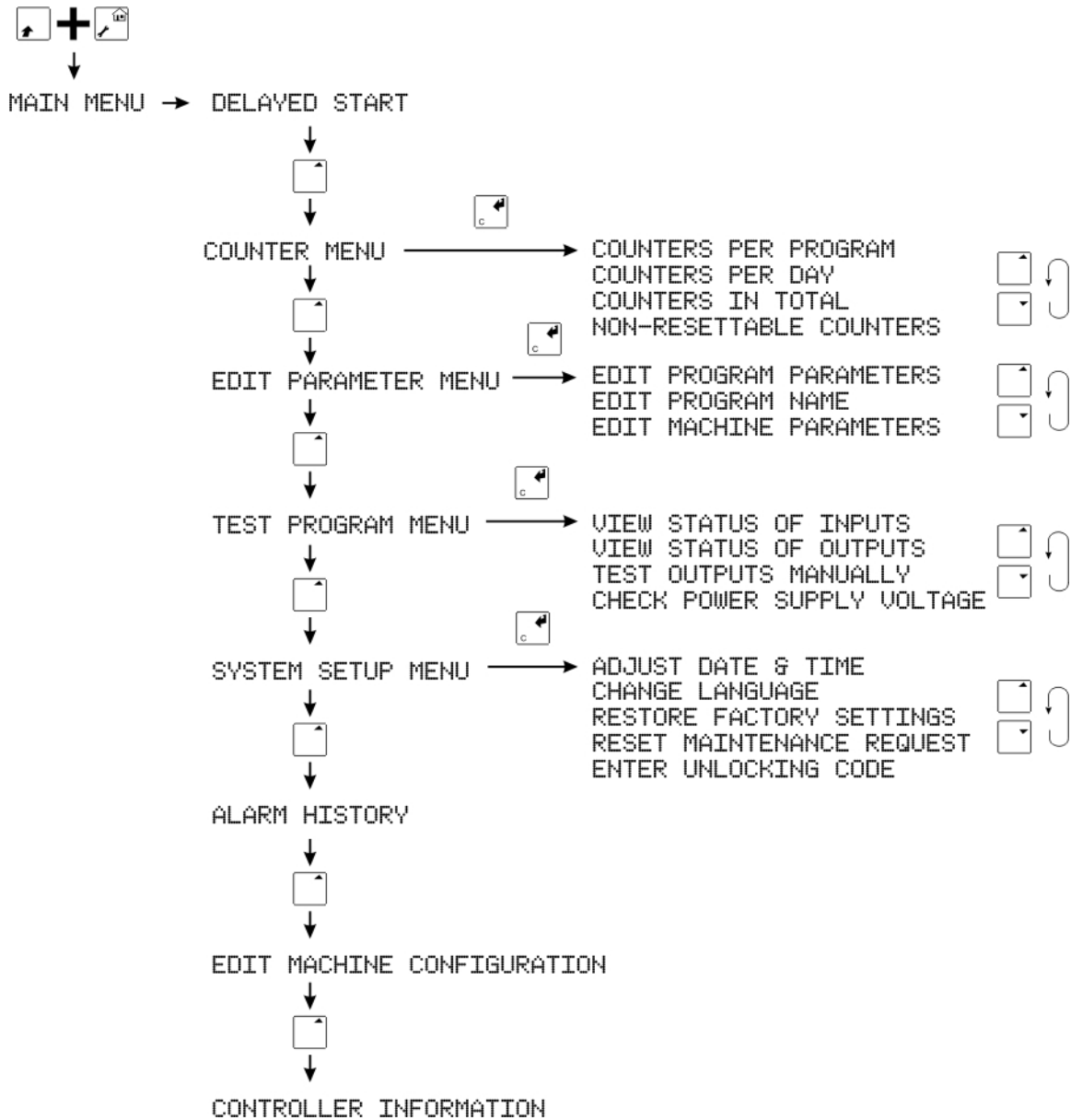

Figure 4.1: M720 Menu Structure

Table 4.1: M720 Passwords

Level	Password	Description
1	1234	Reset counters per program
		Edit program parameters
		Edit program name
		Test outputs manually
2	9999	Reset counters in total
		Edit machine parameters
		Change language
		Restore factory settings
3	1658	Edit machine configuration

### 4.3 Delayed Start

With the M720 controller it is possible to define a delayed start. If this menu item is chosen, the screen for entering the start delay will be displayed.

In this screen the number of hours and minutes delay can be entered. Changing values can be done with the NUMERIC keys and with the PLUS and MINUS buttons. Changing the cursor to another edit field can be done with the ARROW UP and/or ARROW DOWN buttons. Confirming a value must be done with the ENTER key.

If the ENTER key is pressed when the cursor is on the minute field, the delayed start will be activated and the overview screen will be activated again. If both the number of hours and the number of minutes are set to 0, the delayed start timer will be preset to 30 seconds, which is the minimum time for a delayed start. The maximum time adjustable for a delayed start is 11 hours and 59 minutes.

In the overview screen, the message DELAYED START IN: will be displayed, followed by the time until the machine will start in HH:MM:SS format.

The dryer will count down until the delayed start time displayed is 0, and then it will start the selected program. For safety reasons, the beeper will sound 5 seconds before the machine starts.

If delayed start is activated, and a program cycle is started manually, the delayed start will be canceled. Canceling the delayed start can also be done with the STOP key.

### 4.4 Counter Menu

If the item COUNTER MENU is chosen from the main menu, the screen with the counter menu will be displayed. In this menu, an item can be selected with the ARROW UP and/or ARROW DOWN key. Confirming the choice of an item must be done with the ENTER key

The M720 dryer controller has 4 sets of counters. The first set is Counters Per Program. Every

drying program has its own counters. The second and third set are for a counter set per day (Counters Per Day) and counter set with totals of all programs and all days (Counters In Total). The fourth set is a non-resettable counter set, used to read counters processed since the controller was fabricated.

### 4.4.1 Counters per Program

With the counter set Counters Per Program the user can read how many batches and how many operating minutes have been done in a certain program. If Counters Per Program is chosen from the counter menu, the counters of the current active program will be displayed. On the 1<sup>st</sup> line the number and name of the program can be seen. The 2<sup>nd</sup> line has the name of the counter, followed by the value of the counter.

With the PLUS and MINUS buttons the counters of the next and previous program can be viewed. Scrolling through the available counters per program is done with the ARROW UP and ARROW DOWN buttons. There are 2 different counters:

- **Number of batches**  
The number of batches processed in this program since the last reset
- **Running minutes**  
The number of minutes a program cycle has been active using this program since the last reset

Resetting the counters of a program can be done by pushing the CLEAR key (SHIFT key and ENTER key together). Depending on the adjustment in machine parameter 16, the controller may ask for a password. Password level 1 is necessary to be able to reset the counters of a program. If the clear key is pressed and the password level is sufficient, all counters of this program will be set to 0.

### 4.4.2 Counters per Day

With the counter set Counters per day, the user can read how many batches and how many operating minutes have been done on a certain day. The controller saves the production data of the last 50 days the machine has been used. After 50 days, the oldest record will be deleted and replaced by a record of the current date.

If, in the Counter menu the item Counters per day is chosen, the counters of the current day will be displayed. On the 1<sup>st</sup> line, the date can be seen in DD-MM-YYYY format. With the PLUS and MINUS buttons, the counters of the next and previous day can be viewed. With the ARROW UP and ARROW DOWN buttons, one can scroll through the available counters per day. In this case there are 2 different counters:

- **Number of batches**  
The number of batches processed this day

- **Running minutes**

The number of minutes a program cycle has been active this day.

It is not possible to reset the day counters. This is also not necessary since a new counter record will start from 0 automatically every day.

To be able to use the counters per day information, it is important to ensure date and time are programmed correctly. See Section 4.7.1 on page 33.

### 4.4.3 Counters in Total

With the counter set Counters in total, the user can see how many batches and how many hours the machine has run in total, so not depending on the day or the program. Selecting the item Counters in total from the counter menu will display the total counters. With the ARROW UP and ARROW DOWN buttons one can scroll through the available total counters. In this case there are 2 different counters:

- **Number of batches**

The number of batches processed in total since the last reset

- **Running hours**

The number of hours the machine has been running since the last reset

Resetting the total counters can be done by pushing the CLEAR key (SHIFT key and ENTER key together). Password level 2 is necessary to be able to reset the total counters. If the CLEAR key is pressed and the password level is not sufficient, the controller will first ask for a password. If the password level is sufficient, all total counters will be set to 0.

### 4.4.4 Non-resettable Counters

With the counter set Non-resettable counters, the user can see how many batches and running hours the controller has done since it was installed. Also the maintenance request counter can be viewed in this list (see machine parameter 5 and Section 4.7.4 on page 34).

With the ARROW UP and ARROW DOWN buttons, one can scroll through the available counters. In this case there are 3 different counters:

- **Number of batches** The number of batches processed in total since fabrication.
- **Running hours** The number of hours the machine has been running since fabrication.
- **Maintenance cycles** The number of batches still to do until a maintenance request will be done (see also machine parameter 5 and Section 4.7.4 on page 34).

As the name suggests nonresettable counters cannot be reset. Also they are saved in EEPROM memory and not in battery backed-up memory. This means that, unlike the other 3 counter sets, these counters will not be lost when the battery fails or is removed.

## 4.5 Edit Parameter Menu

The controller has 3 sets of parameters. There are parameters which can be programmed specifically for a drying program, so a program can be set-up to process a specific material. These are the program parameters. The machine parameters are general parameters which are always used, regardless of the active program. Configuration parameters are parameters which describe the options in the machine and are typically set by the manufacturer. Program parameters and machine parameters can be accessed via the Edit parameter menu item in the main menu. Configuration parameters can be accessed via the separate item Edit configuration parameters in the main menu. The Edit parameter menu is also used to change the name of a program.



If, in the main menu, the item Edit parameter menu is selected, this menu will be activated. In this menu, an item can be selected with the ARROW UP and/or ARROW DOWN key. Confirming the choice of an item must be done by pressing the ENTER key.

### 4.5.1 Edit Program Parameters

The program parameter list is a list of parameters which can be programmed to create a specific program. The parameters in this list are only used in the current program. To edit program parameters, password level 1 (1234) is required.

**Before entering into programming mode, select the program that needs editing on the keypad. For example, if you wish to edit program 19, press the 1, then the 9 key, then ENTER so that 19 shows on the display. Alternatively, use the up and down arrows to navigate to the appropriate program.**

In the Edit Program Parameters screen, each different parameter can be selected with the up and down arrow keys. A value can be changed with the plus and minus keys, or with the numeric keys. Changing the value must be confirmed by pressing the enter key. The upper line will show the number and name of the parameter, followed by the value.

On the lower line, the maximum and minimum limits will be displayed. The  icon indicates if it is possible to move up or down in the list, and the  icon is displayed to indicate if it is possible to increase or decrease (change) the selected value.

If the SHIFT key is used in combination with the ARROW UP or ARROW DOWN the controller will move to the first or last item in the list. If the SHIFT key is used in combination with the PLUS or MINUS keys, the value will be increased and decreased in larger steps. Refer to Figure 4.2 on page 22 for details.

The following program parameters are available:

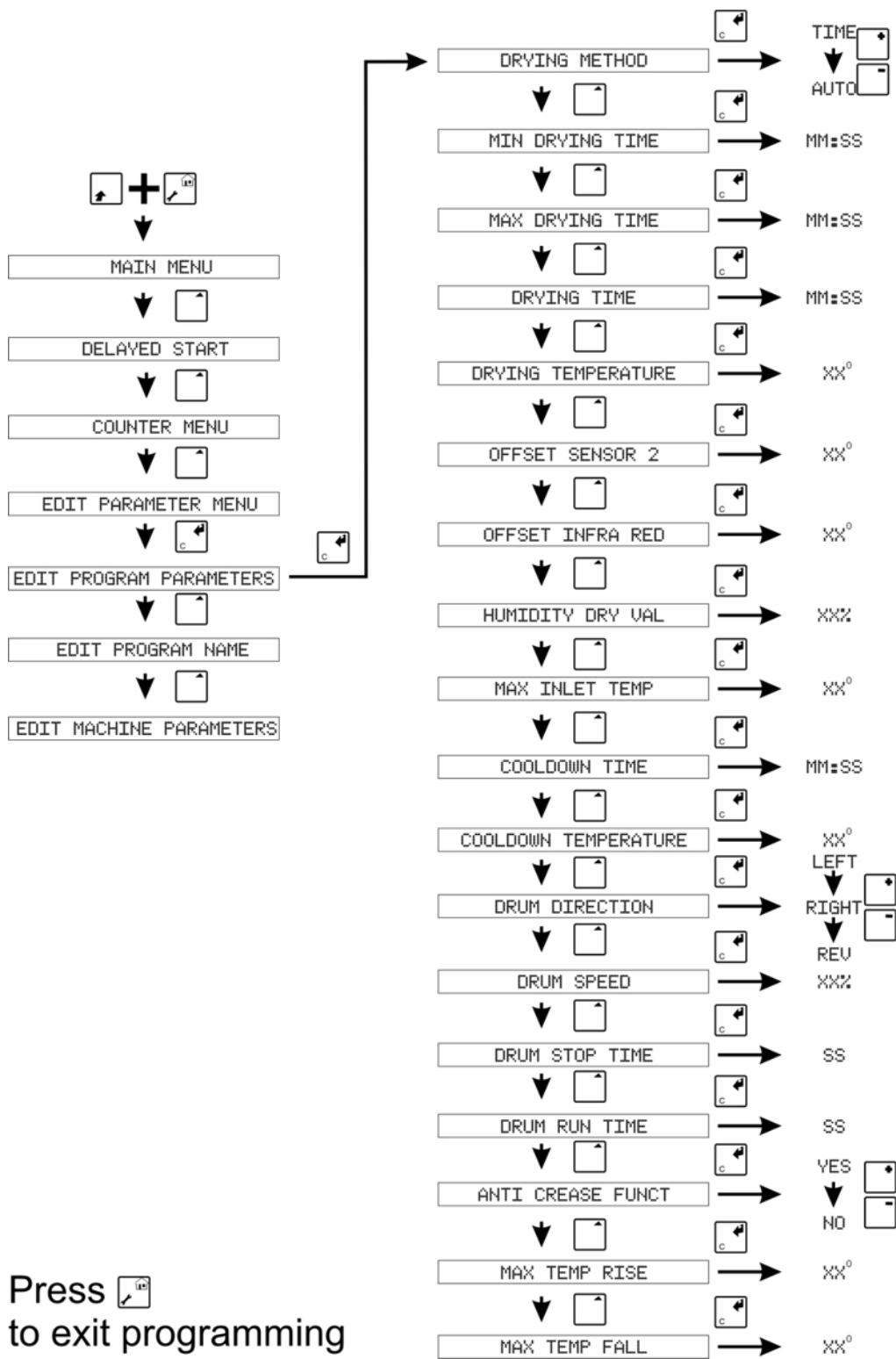

Figure 4.2: M720 Program Parameter Menu

## 1. **Drying method**

The standard controller is equipped with 1 temperature sensor – this parameter will not be available. If the machine is equipped with a second temperature sensor, a humidity sensor or with an infra-red sensor, this parameter will be available and can be set to TIME or to AUTO. If the parameter is set to TIME the program will do drying purely based on time, which means a drying step will always last exactly as long as the programmed drying time (see program parameter 6). If this parameter is set to AUTO the drying step will last until the controller has detected the batch is dry. Determination if the batch is dry is done with parameters 8, 9 and 10. If the batch is considered dry, the cool-down step will be started.

## 2. **Min. drying time**

If the program is set to automatic drying (see parameter 1), this parameter will be available. This parameter is the minimum drying time in minutes. This time is started when the drying cycle is started. During this time the controller will not check if the current batch is dry.

## 3. **Max. drying time**

If the program is set to automatic drying (see parameter 1), this parameter will be available. This parameter is the maximum drying time in minutes. If a batch has been in the drying cycle for this time, and it has still not been detected as dry, it will stop the drying cycle anyway.

## 4. **Drying time**

The time the drying step is activated (see parameter 1). This parameter can only be set if no automatic drying is available or when parameter 1 is set to time.

## 5. **Drying temperature**

The target temperature for drying during the drying step. If the drying time is set to 0 (parameter 6), this parameter will not be available.

## 6. **Offset sensor 2**

This parameter is available in case 2 temperature sensors are installed and the drying method (see parameter 1) is set to AUTO. This parameter is the temperature difference the 2<sup>nd</sup> temperature sensor (in the inlet of the drum) has to measure compared to the standard temperature sensor to detect if the batch is dry.

This means that after the programmed minimum drying time (see parameter 2), if the temperature difference between sensor 1 and sensor 2 is less than the value programmed with this parameter, the batch is considered to be dry.

So, for example, if the temperature measured on the drum temperature (sensor 1) is 63°C and this parameter is set to 5°C, the batch is considered to be dry when the temperature measured on the inlet (sensor 2) is less than 68°C.

## 7. **Offset infra-red**

This parameter is available in case an infra-red sensor is installed and the drying method (see parameter 1) is set to AUTO. This parameter is the temperature difference between the infra-red sensor and the temperature sensor to detect the batch as dry.

So, for example, if the temperature measured on the drum sensor (the standard temperature sensor) is 63°C and this parameter is set to 5°C, the batch is considered to be dry when the temperature measured by the infra-red sensor is higher than 58°C.

#### 8. **Humidity dry val.**

This parameter is available only when a humidity sensor is installed and the drying method (see parameter 1) is set to AUTO. This parameter is the humidity percentage to be detected in order to determine that the batch is dry.

If the humidity sensor detects a humidity percentage less than or equal to the programmed value, the batch is considered to be dry.

#### 9. **Max. inlet temp.**

This parameter is available when a 2<sup>nd</sup> temperature sensor on the inlet is installed. With this parameter, the maximum temperature of the air coming into the inlet can be limited to protect the loaded goods. For example, if this parameter is set to 175°C, the heating output will be switched off when the inlet temperature sensor (sensor 2) measures a temperature higher than 175°C.

#### 10. **Cooldown time**

The maximum time the cool-down step may last. If the programmed cool-down temperature (parameter 19) is not reached within this time, the program will finish anyway.

#### 11. **Cooldown temperature**

The target temperature in the cool-down step. If this temperature is reached in the cool-down step, the program will finish.

#### 12. **Drum direction**

The direction of the drum during drying, cool-down and anti-crease. If a reversible drum is configured in the machine configuration (see Section 4.9), this parameter can be used to set the drum direction.

- **Left:** Only turn left (output 5), drum will never stop
- **Right:** Only turn right (output 6), drum will never stop
- **Rev:** Toggle between left (output 5) and right (output 6), runtime and stop time adjustable with program parameters 15 and 16)

If no reversing drum is configured, this parameter will not be available.

#### 13. **Drum speed**

If the machine is equipped with an inverter (see Section 4.9, machine configuration), this parameter can be used to adjust the drum speed during drying, cool-down and anti-crease. The value of this parameter is a percentage of the maximum speed. So if this parameter is set to 50%, the drum will run at half the maximum speed. When no drum with frequency inverter is installed, this parameter will not be available.

#### 14. **Drum stop time**

If the machine is equipped with a reversing drum motor, and program parameter 13 is set to reversing, this parameter allows the time the drum will stop when switching direction to be defined. So, after running for the time defined in parameter 16, the drum will stop for the time defined in parameter 15 and then start again in the other direction. If no reversible drum is installed or the drum direction is not set to reverse, this parameter will not be available.

**Note:**

This value is an additional value to the minimum stop time, which is 4 seconds. So, for example, if this parameter is set to a value of 6, the stop time will be  $6 + 4 = 10$  seconds.

#### 15. **Drum run time**

If the machine is equipped with a reversing drum, and program parameter 13 is set to reversing, this parameter is the time the drum runs in one direction. After running for the time defined in parameter 16, the drum will stop for the time defined in parameter 15 and then start again in the other direction. If no reversing drum is installed or the drum direction is not set to reverse, this parameter will not be available.

#### 16. **Anti crease funct.**

This parameter indicates if the anti-crease function is enabled in this program. When a program finishes, the drum will stop for 2 minutes. If anti-crease is enabled the drum will run again for two minutes, then pause for 2 minutes. This will continue until the door is opened. During anti-crease the blower will not be on. This means that if the drum motor is connected together with the blower motor, the anti-crease function will not work.

#### 17. **Max. temp rise**

The maximum temperature rise rate in degrees per minute during a drying cycle. During drying the controller will adjust the temperature control function so that the temperature will not rise more than this programmed maximum. If this value is set to 0, no maximum rise is active, and the controller will try to reach goal temperature as soon as possible.

#### 18. **Max. temp fall**

The maximum temperature fall rate in degrees per minute during a cool-down cycle. During cool-down the controller will adjust the temperature control function so that the temperature will not fall more than this programmed maximum. If this value is set to 0, no maximum fall is active, and the controller will try to reach goal temperature as soon as possible.

### 4.5.2 **Edit Program Name**

A program name can be set for each program. This name describes the type of material for which the program has been set up. The maximum length of a program name is 32 characters.

When the screen is activated, the cursor will be on the first character. The cursor can be moved with the ARROW UP and ARROW DOWN keys.

Changing the character where the cursor is on can be done with the numeric keypad, in more or less the same way text messages are created on cell-phones. See Table 4.2 on page 26 and Figure 4.3 on page 27 for details.



Table 4.2: M720 Program Naming Key Functions

key	Character Sequence
1	, . / ( ) ° 1
2	a b c A B C 2
3	d e f D E F 3
4	g h i G H I 4
5	j k l J K L 5
6	m n o M N O 6
7	p q r s P Q R S 7
8	t u v T U V 8
9	w x y z W X Y Z 9
0	0 [SPACE]

### 4.5.3 Edit Machine Parameters

The machine parameter list is a list with parameters which can be programmed to set-up general parameters in the machine. These parameters are used for all programs. Because they are valid for all programs, machine parameters are only accessible via the level 2 password.

In the edit machine parameters screen, parameters can be selected with the ARROW UP and ARROW DOWN keys. A value can be changed with the PLUS and MINUS keys, or with the numeric keys. Changing the value must be confirmed with the ENTER key. The upper line will show the number and name of the parameter, followed by the value.

On the lower line, the maximum and minimum limit will be displayed. If the  icon is shown, it is possible to move up or down in the list, if the  icon is shown it is possible to increase or decrease the value. If the SHIFT key is used in combination with the arrow keys, the controller will move to the first or last item in the list. If the SHIFT key is used in combination with the PLUS and MINUS keys, the value will be increased or decreased in larger steps. Refer to Figure 4.4 on page 28 for more details.

The following machine parameters are available:

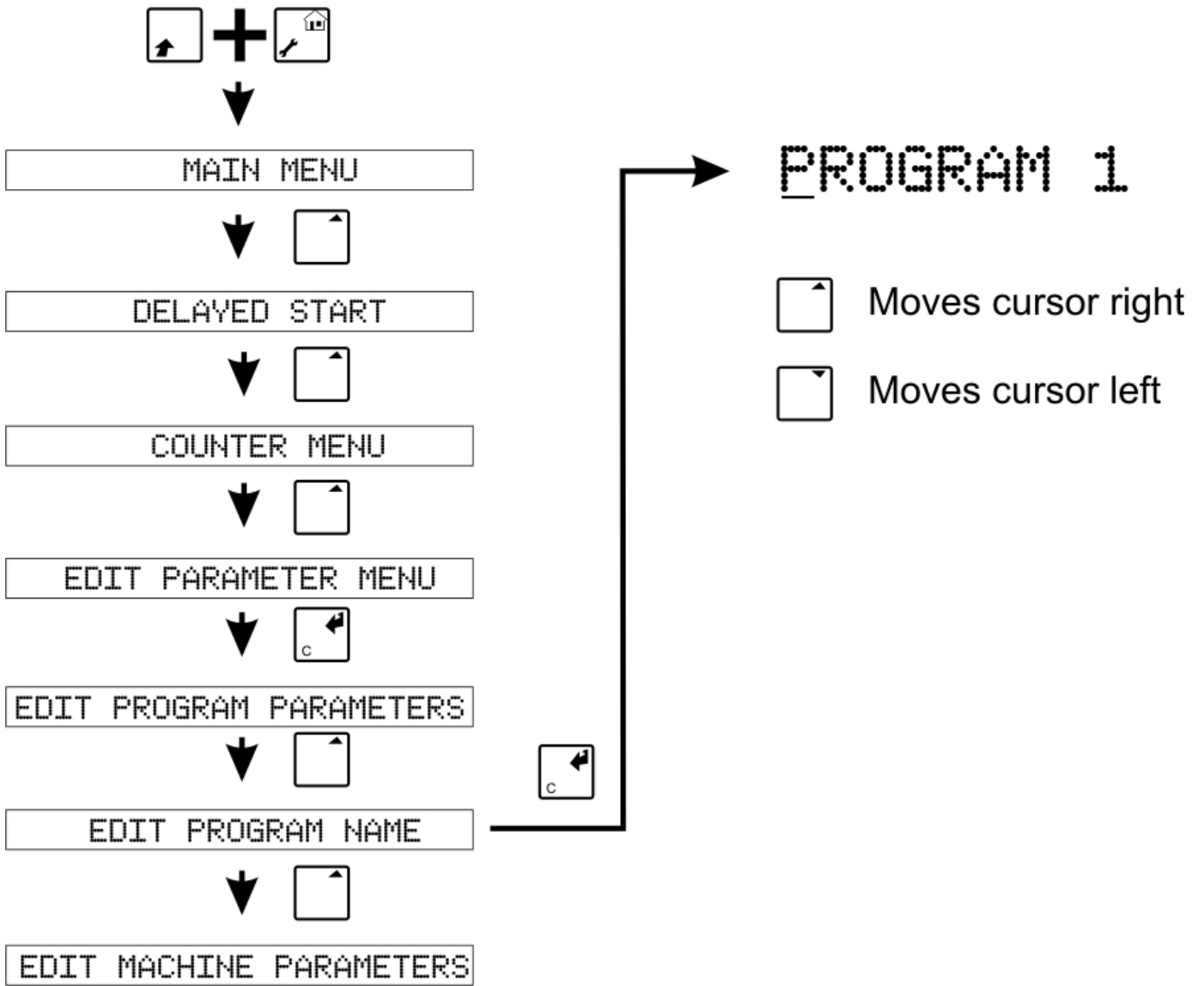

Figure 4.3: M720 Program Naming Menu

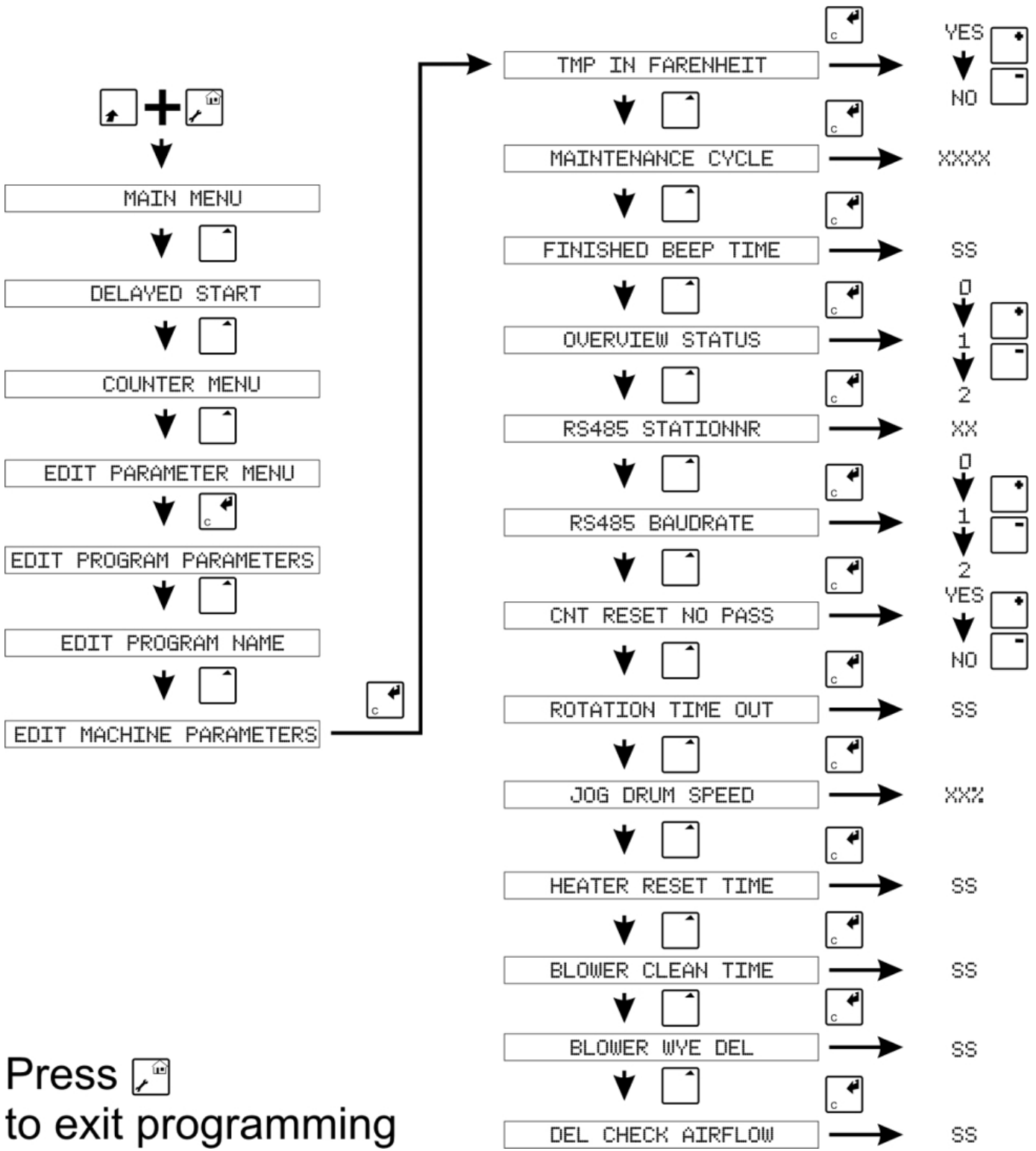

Figure 4.4: M720 Machine Parameter Menu

### 1. **Tmp in fahrenheit**

Set this parameter to YES if all temperature settings and displays should be displayed in Fahrenheit units instead of Celsius. If this parameter is NO, all temperature settings and displays will be displayed in Celsius units.

Note: This value only changes the units used for displaying temperature values. Internally the controller always works with Fahrenheit units.

### 2. **Maintenance cycle**

Use this parameter for setting the number of batches until a maintenance request is done. If, for example, the value of this parameter is 500 then as soon as 500 batches have been done the controller will show the message Maintenance request when the machine is in rest. The maintenance counter can be reset again in the System Setup menu, item Reset maintenance request (see Section 4.7.4 on page 34). The number of batches which still can be done until a maintenance request is displayed, can be read in the non-resettable counters screen (see Section 4.4.4 on page 20).

If this parameter is set to 0, the maintenance request option is disabled and no maintenance request will be displayed.

### 3. **Finished beeptim.**

When a program is finished, the controller will activate the beeper. This parameter is the time the beeper will beep when a cycle is finished. This time is repeated every 2 minutes until the door has been opened.

### 4. **Overview status**

This parameter is used to control the 2<sup>nd</sup> line in the display in the overview screen when the machine is running.

- **Value 0:** Toggle between current time left (see value 1) and current temperatures and step (see value 2)
- **Value 1:** Only show current temperature, temperature set-point and current step.
- **Value 2:** Only show time left in current step and total time left until program is finished.

### 5. **RS485 Stationnr.**

The controller is equipped with an RS485 port to communicate with a PC for downloading translations and monitoring. Every controller in a network must have a unique station number. This parameter is used to set the station number of this controller.

### 6. **RS485 baudrate**

This parameter is used to adjust the communication speed of the RS485 port used for networking multiple controllers and communication with a PC.

- **Value 0:** 115,200bps
- **Value 1:** 38,400bps
- **Value 2:** 9,600bps

Every controller in a network must be programmed to the same communication speed. In cases where long cables are used to connect controllers to the network, or in case of difficulties with communication between PC and controller, often a lower communication speed is necessary. When this parameter is changed, the controller must be restarted.

#### **7. Cnt.reset no pass**

If this parameter is set to yes, the counters per program (see Section 4.4.1 on page 19) can be reset without a password. If this parameter is set to no, password level 1 (1234) is needed to be able to reset the counters per program.

#### **8. Rotation time-out**

If a rotation sensor is defined in the machine configuration (see Section 4.9 on page 35), this parameter is the time the drum is allowed to turn without a signal from the rotation sensor. For example, if the value of this parameter is 10, and the drum has been turning for 10 seconds without a signal from the rotation sensor, the machine will stop and display an alarm. The value of this parameter is based on when the drum is running at full speed. If the machine is equipped with a frequency inverter, the time-out value is automatically recalculated with regard to the programmed drum speed. For example, if the time-out value is 10 and the programmed drum speed is 50%, the internally calculated time-out value will be 20 seconds.

If no rotation sensor is defined in the machine configuration, this parameter will not be visible.

#### **9. Jog drum speed**

If jog buttons and a drum with an inverter have been defined in the machine parameters (see Section 4.9), this parameter is used to adjust the drum speed in case jogging is active. The value is a percentage of the maximum speed. For example, if 30% is programmed, the speed of the drum motor in case of jogging will be 30% of the maximum.

If no jog buttons or no drum with an inverter is programmed, this parameter will not be visible.

#### **10. Heater reset time**

Some types of heaters require a reset signal before they will restart after a fault alarm. When a program is started the output for resetting the heater will be activated (output 1) as standard. This parameter is the number of seconds the output will be on when starting a program. The value used will depend on the type of heater (refer to the heaters instructions for this).

#### **11. Blower clean time**

When a program is started the output for an optional clean signal (like an air blast) for the blower will be activated (output 3). This parameter is the number of seconds the output will be on when starting a program.

#### **12. Blower WYE del.**

If the machine is equipped with a star/delta arrangement to start the blower motor this parameter is the delay for switching the blower star/delta switch from off to on after restarting the blower.

### 13. Del. check airflow

When a program is started the controller will check if the airflow switch (input 3) is in the off position. After that the blower will be started. After starting the blowers the airflow switch should go to the on position within a given period otherwise an alarm will be displayed. This parameter is the delay interval between the moment the blower starts and the moment the airflow switch should be in the on position.

## 4.6 Test Program Menu

To be able to track malfunctions and to check correct functioning of all inputs and outputs, the M720 controller is equipped with various test functions. These test functions can help service staff to find malfunctioning inputs or outputs faster.

If the item Test program menu is selected from the main menu, this menu will be activated. In this menu an item can be selected with the ARROW UP and/or ARROW DOWN key. Confirming the choice of an item must be done with the ENTER key.

### 4.6.1 View Status of Inputs

In this screen all available inputs can be monitored. When the screen is activated, the module number will be set to 0. Module 0 is the controller itself. If extension boards are connected, an extension board can be selected with the ARROW UP and/or ARROW DOWN key. If no extension boards are connected, the arrow keys will not be visible. Module number 1 is the extension board with address number 1, module 2 is the extension board with address 2, and so on.

After selecting a module number, an input number can be chosen with the PLUS and MINUS keys. The dryer controller itself has 16 inputs, extension boards each have 8 inputs. If module number 0 is selected, the input number can vary between 1 and 16. If an extension board (module number 1 to 8) is selected, the input number can vary between 1 and 8.

On the lower line of the display, the current status of the input is shown. If an input receives a 24V signal the status of the input will be ON and if no signal is received on the input, the status of the input will be OFF.

The following example will explain how to test the door closed input. The input for door closed is input 1 on the dryer controller. To check the status of this input first select module number 0 with the ARROW UP and/or ARROW DOWN key. Module number 0 means viewing the inputs on the dryer controller itself. After that select channel number 1 with the PLUS and/or MINUS. Channel number 1 means input 1. If the module number is set to 0, and the channel number is set to 1, the input status of the door closed input is shown. If the door is closed, the status of the input should be ON. If the door is opened, the status of the input should change to OFF.

## 4.6.2 View Status of Outputs

The View status of outputs screen can be used to check if the controller board is activating an output. Viewing the status of an output can be done while the machine is running. Selecting a module number and channel number is done in the same way as in the View status of inputs screen (see section 4.6.1 on page 31). The main difference between viewing the status of the inputs and viewing the status of the outputs is the number of available outputs on the dryer controller itself. The dryer controller has 8 relay outputs and 1 digital outputs. This means that if module number 0 is selected, the channel number can be varied between 1 and 9.

## 4.6.3 Test Outputs Manually

This test program can be used to manually activate an output. Because the user takes over control of all available outputs, password level 1 is necessary to be able to run this test program. Also, if a program cycle is active, this cycle will be stopped to prevent the dryer from restarting automatically if the user quits this test program.

Selecting a module and channel is done in the same way as selecting an output in the View status of outputs screen (see section 4.6.1 on page 31 and section 4.6.2 on page 32).

The screen will look the same as the View status of outputs screen, with the difference that the status of the output is controlled with the ENTER key. If the right output is selected by setting the right module and channel number, the output will be in the OFF state initially. When the ENTER key is pressed, the output will be switched on, and the state will change to ON. The output will stay in the ON state as long as the ENTER key is pressed and will return to the off state when the ENTER key is released.

The following example explains how to test the blower output. The blower output is output number 7 on the dryer controller. If necessary, select module number 0 with the ARROW UP and/or ARROW DOWN key. Module number 0 means testing the outputs on the dryer controller itself. After that, select channel number 7 with the PLUS and/or MINUS keys. Channel number 7 means output 7. If the module number is set to 0, and the channel number is set to 7, the blower output is selected. If the ENTER key is not pressed, the output status will be OFF. If the ENTER key is pressed, the controller will switch on the relay at output 7 and the state will go to ON.

## 4.6.4 Check Power Supply Voltage

The dryer controller has an on-board facility to monitor the voltage supplied to the controller. If the power supply voltage drops below the low voltage limit or rises above the high voltage limit, all outputs will be switched off and an alarm message is displayed (see Chapter 5 on page 39).

When Check power supply voltage is chosen in the Test program menu, the screen will show the current power supply voltage.

## 4.7 System Setup Menu

The System set-up menu is a menu with items which are not directly related to the control functions of the machine itself but define the complete installation and user interface. The available items are used to set-up some extra features of the controller.

### 4.7.1 Adjust Date and Time

Password level 1 is required to be able to adjust current date and current time. When the item Adjust date & time is chosen from the System setup menu the screen will show the current date & time in the display, with the cursor blinking on the first edit-field (the day field in the date). The current date can only be viewed and edited in a DD-MM-YYYY format. The displayed time is in HH:MM format.

The programmed date and time are internally used in the controller to create an alarm history list with start times and active times (see Section 4.8 on page 35) and for the counters per day. At the moment a new day begins according to the date and time programmed in this controller, a new counter record for the new day will be created (see Section 4.4.2 on page 19).

To adjust the value of the field where the cursor is, use the numeric keys and/or the PLUS and MINUS keys. Confirm the new value with the ENTER key. The cursor can be moved to the next or previous edit field with the ARROW DOWN and ARROW UP keys.

### 4.7.2 Change Language

Password level 2 is required to change the language of the controller display. When Change language is chosen from the System setup menu, the first line will tell the user to select a language from the list. The 2<sup>nd</sup> line shows the name of the current language, like for example ENGLISH. Now, a language can be selected with the ARROW UP and ARROW DOWN keys. When the language is selected, this choice can be confirmed with the ENTER key.

Because the M720 controller has a full world-wide character set, it is possible that the controller is set to a language which can not be read and/or understood. This can also happen if the language is accidentally changed to another language.

If this happens, it would be difficult to go through the available menus and find the Change language item again. Therefore, a work-around is available. When switching the controller off and on again, the start-up logo (or an empty screen) will be shown for around 4 seconds. If, during this time, the SHIFT key and the ENTER key are held simultaneously, the screen to change the language will be activated as well, so another language can be selected.

### 4.7.3 Restore Factory Settings

Restoring factory settings should normally not be necessary because all parameters are stored in non-volatile memory, which does not need a battery to retain its data. But, in some cases it can be useful to be able to go completely back to factory settings.

If the item Restore factory settings is chosen from the System setup menu, and the password level is sufficient, the screen for restoring factory settings will be displayed. If the password level is too low, the password screen will be activated. A password level 2 is necessary to get access to the factory settings screen.

If the screen for restoring factory settings is displayed, the factory settings can be restored by pushing the SHIFT key and NUMERIC 9 key at the same time. When factory settings are restored, the overview screen will be activated again. Because restoring the factory settings is a time consuming process, the normal program cycle can be halted for a while. During the time needed to restore all factory settings, the beeper will sound continuously.

Please note that restoring factory settings will restore the factory settings of all drying programs and the settings of the machine parameters. These parameters are set as described in Chapter 6 on page 43. Restoring factory settings does **not** change the configuration parameters. They will not be influenced by this operation.

### 4.7.4 Reset Maintenance Request

With machine parameter number 5 (see section 4.5.3 on page 26) it is possible to set a maintenance request count. For example, if machine parameter 5 is set to 500, and 500 batches are done the display will show Maintenance request before the machine can be started for a new program cycle (see also Chapter 5, Alarms on page 39). This Maintenance request will be active until the message is reset via the System setup menu item Reset maintenance request. If this item is selected a special password must be entered (see Section 4.2 on page 16). For resetting the maintenance request the password is 1111. The remaining number of batches until the next maintenance request message is displayed can be seen in the non-resettable counter set, see section 4.5.3.

### 4.7.5 Enter Unlocking Code

In special circumstances it is possible that the control system locks itself. If the control panel is locked, message 5 will be displayed. To unlock the controller again, it is necessary to enter an unlock code. In the Enter unlocking code screen, the serial number of the controller is displayed. With this serial number, the machine manufacturer is able to determine the unlocking code which should be used for this controller. When the controller is locked it will automatically show the enter unlocking code screen after every restart.

## 4.8 Alarm History

The alarm history list can be viewed by selecting Alarm history in the main menu. The alarm history is a list with the last 50 alarms, warnings and messages which have occurred. The alarm history is stored in the battery backed-up memory.



In the alarm history screen the upper line displays which record number is currently displayed. Scrolling through the list of records is done with the ARROW UP and ARROW DOWN keys. The maximum number of items saved is 50.

The time the alarm started is shown on the right side of the upper line. The lower line shows the alarm number and alarm text (see Chapter 5 on page 39 for a complete list of all available alarms, warnings and other messages). The number of minutes the alarm has been active is displayed on the right side of the lower line. The maximum value is 240. When an alarm is active for longer than 240 minutes (or 4 hours) the controller will stop counting. The minimum time is 1 minute. If an alarm is active for less than 1 minute the number of minutes will be set to 1 anyway. If the alarm is still active, a ? will be shown instead of a value. If an alarm was active when the controller was switched off, the active time will also show a ?.

In order for the alarm history list to work properly it is important that the controller date and time are set to the correct values. Section 4.7.1 on page 33 describes how to set the correct date and time.

## 4.9 Edit Machine Configuration

The machine configuration is a list of parameters which can be programmed to set-up the available options of the machine. Because these parameters influence the way the machine works and because setting the wrong values can cause a complete machine stop, these parameters are only accessible with the highest password level. Usually, these parameters are programmed once after installing the machine. If the configuration has been set-up properly during installation, there is no need to change the values unless there are changes to the physical installation.

In the edit machine configuration screen, a parameter can be selected with the ARROW UP and ARROW DOWN keys. A value can be changed with the PLUS and MINUS keys, or with the numeric keys. Changing the value must be confirmed with the ENTER key. The upper line will show the number and name of the parameter, followed by the value. On the lower line, the maximum and minimum limit will be displayed. With the  icon is indicated if it is possible to still move up or down in the list, with the  icon is indicated if it is possible to increase or decrease the value.

If the SHIFT key is used in combination with the arrow keys, the controller will move to the first or last item in the list. If the SHIFT key is used in combination with the plus and minus keys, the value will be increased and decreased in larger steps.

*Note: After changing the value of a machine configuration parameter, press the ENTER key to confirm. After all changes are made, you must press the HOME key to confirm all changes.*



to confirm change, followed by



after all changes are made.

The following configuration parameters are available:

#### 1. **Startup logo nr.**

When the controller starts up a start-up logo will be displayed for 5 seconds. Depending on manufacturer and distributor, it can be useful to change the start-up logo. If the value of this parameter is 0, no start-up logo will be displayed.

#### 2. **Humidity sensor**

This parameter indicates if a humidity sensor is present in the exhaust. This sensor is used for automatic drying which means that the controller can measure if the batch is dry and stop the drying cycle instead of running on a fixed (too long) drying time.

#### 3. **2<sup>nd</sup> temp. sensor**

This parameter indicates if a 2<sup>nd</sup> temperature sensor is connected. This means that an extra temperature sensor is mounted at the air inlet of the machine. This sensor is used for automatic drying, which means that the controller can measure if the batch is dry and stop the drying cycle instead of running on a fixed (too long) drying time. If this sensor is present, it is also possible to limit the inlet air temperature with machine parameter number 40.

#### 4. **Infra-red sensor**

This parameter indicates if an infra-red sensor is available to measure the linen temperature. The infra-red sensor is used for automatic drying, which means that the controller can measure if the batch is dry and stop the drying cycle instead of running on a fixed (too long) drying time.

#### 5. **Reversible drum**

This parameter indicates if the drum can turn left and right with a reverse relay. If this parameter is set to yes, output 5 and 6 are used for the motor direction and in the program parameters, parameters 13, 15 and 16 are used to adjust the motor direction, motor run time and motor stop time.

#### 6. **Drum with freq.inv**

This parameter indicates if the drum motor is controlled with an inverter. If so, the drum speed can be controlled by connecting the analogue output of the controller to the analogue input of the inverter. With program parameter 14 the drum speed can be programmed per program.

#### 7. **Status output func**

This parameter sets the function of the status output (output number 2), which can be used to give a signal to an external system or for example to connect an alarm light.

- **Value 0:** Output on when a drying cycle or cool-down cycle is busy. In this case the output will be switched on when a drying cycle starts and will switch off when the program is finished. This means that the output will always be on, even if the machine is stopped by an alarm or by the user, until a program is completed.
- **Value 1:** Output on when a program is finished. If a program has been finished, the output will be switched on and will stay on until the door is opened or until the program cycle is stopped by pushing the stop key twice.
- **Value 2:** Output on when the machine is stopped because of an alarm while a drying cycle or cool-down cycle was active.
- **Value 3:** Output on when a program is finished (see value 1) or when an alarm is active during a program cycle (see value 2).

## 8. Rotation sensor

This parameter indicates if the machine is equipped with a rotation sensor. If so the rotation sensor should be connected to input 7. Please note that the rotation sensor must be a 24VDC sensor as the use of 24VAC sensors is not possible. If this parameter is set to Yes, the machine will monitor the sensor when the drum is running. If the drum is running and the rotation sensor has not been detected for a given time interval (see Section 4.5.3, item 26) the machine will be stopped and an alarm will be displayed.

## 9. Jog Buttons

This parameter indicates the presence of jog buttons. If set to Yes the jog buttons should be connected to inputs 12 and 13. Jog keys allow the user to jog the drum motor when the machine is in a stop situation, the emergency stop is not active and the door is closed. If the drum motor is controlled by an inverter a separate motor jog speed can be defined with machine parameter 27.

## 10. EDG replacement

If the controller is to replace an existing EDG controller, this parameter has to be set to Yes. If set to Yes, the machine will perform other checks on the filter door/drawer open input and the overload input. This has to be done so the controller can be replaced by just using the existing connectors without the need of changing the wiring of the switches.

Setting this parameter to Yes also overrules the function of the inputs 8, 9, 10 and 15 (air pressure switch, overheating contact, emergency stop/safety switches and fire suppression input). This means that if an EDG controller is replaced with an M720 controller in an existing machine, this parameter has to be set to Yes and these inputs will not be monitored.

Please note that if an EDG controller is replaced by an M720 dryer controller, the temperature sensor should also be replaced.

## 4.10 Controller Information

The Controller information screen shows the current hardware and software version, and the serial number of the controller. This information can, for example, be used to check if the correct version

of the manual is being used as a reference. This information must also be provided with each support request.

# Chapter 5

## Alarms

If the machine detects an alarm or a warning a message will be displayed on the 2<sup>nd</sup> line of the overview screen. In some cases, the numeric display above the graphical display will also blink with the alarm number.

Alarms can be reset with the START key. Only one alarm is reset at a time so if multiple alarms are active the start key must be pressed once for each alarm. The alarms are the messages with number 1 to 24.

Warnings can also be reset with the start key but will also automatically reset if the cause is solved. The warnings are the messages with number 25 through 30.

Status messages often do not require action. If a status message requires action this is described in the explanation of the message. The status messages are the messages with number 31 until 40.

All alarms, warnings and messages which occurred can be checked in the alarm history screen (see section 4.8 on page 35).

The following alarms, warnings and messages can be displayed:

1. **Emergency stop**

The input for the emergency stop and/or safety switches (input 10) is, or has been, in the off state. This means the emergency stop has been pressed or one of the safety switches has been activated.

2. **Overload protection**

The input for the overload contacts (input 4) is, or has been, in the off state. This means one of the overload protections is activated.

3. **Error frequency inverter**

The input for the error of the inverter (input 11) is, or has been, in the off state. This means that (one of) the frequency inverter(s) gives an error signal.

4. **Error inverter synchronization**

The input for the error of the frequency inverter (input 11) is configured to be a pulse train input. This means that the controller must detect a certain pattern on this input signal. If not, the machine is stopped out of safety issues because if this pulse train is not detected, a malfunction of this signal can be possible.

#### 5. **Control panel blocked**

In some circumstances, it is possible that the controller locks itself. If this happens, an unlocking code must be entered. This can be done via the System Setup menu (see Section 4.7.5) or by switch the controller off and on again. In the Enter unlocking code screen, the unlocking code can be entered. Contact the manufacturer for the right unlocking code.

#### 6. **Gas heater alarm**

The input for the error of the gas heater (input 14) is, or has been, in the off state for minimum 3 seconds. This means the gas heater gives an error signal.

#### 7. **Fire suppression**

The input for fire suppression (input 15) is, or has been, in the off state. This means the fire suppression contact is activated.

#### 8. **Rotation sensor time-out**

While the drum was running, the rotation sensor didnt go from the on to the off state quickly enough. This can mean the drum is jammed or the drum motor isnt working properly.

#### 9. **No air pressure**

The input for the air pressure switch (input 8) is, or has been, in the off state. This means the airflow is insufficient, or the airflow switch is not operating properly.

#### 10. **Lint filter door opened**

The input to detect if the lint filter door or drawer is closed (input 2) is, or has been, in the off state. This means that the lint filter door or drawer has been opened.

#### 11. **Door opened**

The input to detect if the door is closed (input 1) has been in the off state while it should be in the on state. The controller checks if the door is closed when a program is started and when a program is running. If the door is opened, this message will be displayed.

#### 12. **Air flow sensor error**

The input which monitors air flow (input 3) is not detecting the expected signal. When the machine is started the input should be in the off state. After the blower is started the input should change to the on state in the time defined in machine parameter 33. If the input is in the on state when starting up, or does not go to the on state in time then no air flow is detected. As this situation can be dangerous the machine is stopped.

Please note that if a dryer is stopped and then restarted quickly this message can appear. Because of the momentum of the blower motor air will still be flowing and the switch will stay in the on state, for a short time after the blower motor has been stopped. If the machine is started again during this period this message will also be displayed.

Also please note that if the lint filter door or drawer is opened when a program is running the air flow will change which can also cause the switch to open. In this case an additional air flow sensor error will be given.

**13. Temperature sensor 1 error**

The cable of temperature sensor 1 is broken or there is a short circuit, or the sensor has failed. The controller detects that the sensor is not properly connected or is malfunctioning.

**14. Temperature sensor 2 error**

The cable of temperature sensor 2 is broken or there is a short circuit, or the sensor has failed. The controller detects that the sensor is not properly connected or is malfunctioning. This message will only be displayed in case the presence of a second temperature sensor is set in the machine configuration parameters (see Section 4.9, parameter 4). The machine is still able to run in case the 2<sup>nd</sup> sensor is broken, but it cannot run on automatic drying any more (see Section 4.5.1, program parameter 1). In order to run the machine the sensor should be replaced or a program with time-based drying should be chosen.

**15. Error power supply**

The 24V power supply is too low (below 20 Volts) or too high (above 40 Volts). Because this can cause damage to the controller, it has switched all outputs off. The actual power supply voltage can be checked at any time from the test program menu (see Section 4.6.4 on page 32).

**16. Battery empty**

When starting up the controller checks if the battery backed-up memory is correct. If not, this message will be displayed. This message will only be displayed after startup. The battery capacity is enough for 1 year, so it is strongly recommended to replace the battery yearly. The START key must be pressed to reset the message.

**17. Microprocessor restarted**

The dryer controller is able to monitor its power supply. If the power supply voltage is too low, or too high, alarm 18 will be displayed. If the power supply voltage is too low for the controller to be able to operate the microprocessor will reset itself. This can happen in case of a sudden, brief voltage drop. If this happens the microprocessor will store this and the next time the controller starts up, alarm 20 will be shown on the display.

**18. Infra-red sensor read error**

The presence of an infra-red sensor has been indicated in the machine configuration parameters (see Section 4.9 on page 35, parameter 5), but the controller cannot detect a working infra-red sensor. This means it cannot determine the batch is dry. The machine is still able to run in case the infra-red sensor is broken, but it cannot run on automatic drying any more. In order to run the machine, the sensor should be replaced or a program with time-based drying should be chosen.

**19. Humidity sensor read error**

The presence of a humidity sensor has been indicated in the machine configuration parameters (see 4.9 on page 35), but the controller cannot detect a working humidity sensor. This

means it cannot determine if the batch is dry. The machine is still able to run if the humidity sensor is broken, but it cannot run on automatic drying any more. In order to run the machine, the sensor should be replaced or a program with time-based drying should be chosen.

**20. Clean lint filter**

The dryer controller will monitor input 16 to check if the filter needs to be cleaned. If the controller detects that the filter needs to be cleaned this message will be displayed. This message is automatically removed when the filter is clean again or when the machine is stopped.

**21. Overheating switch**

The input for the overheating switches (input 9) is, or has been, in the off state while the heater was switched on. This means that (one of) the overheating switch(es) is activated. When the overheating switch isnt active anymore, the message will be reset.

**22. Delayed start in:**

Delayed start has been programmed and the timer for the delayed start is counting down to 0. At the moment the counter reaches 0, the machine will automatically start (see Section 4.3 on page 18)

**23. Maintenance request**

The maintenance request counter is 0 and the machine needs maintenance. The number of batches which can be done between 2 maintenance requests is adjustable with machine parameter 5). Resetting the maintenance request can be done via the System Set-up menu (see Section 4.7.4 on page 34).

**24. Waiting for cycle restart**

While a program was running the machine was stopped, either by an alarm or by pushing the STOP key. If the START key is pressed the machine will continue its cycle. If the STOP key is pressed the program cycle will be stopped.

**25. Program finished** A program is finished. If the door is opened the machine will finish and start from the beginning again.

**26. Press  to start**

The machine is ready to start a new program. If the START key is pressed, and all inputs are okay, a program cycle will start.

# Chapter 6

## Default Settings and Default Programs

### 6.1 Default Values

Because the used language can vary, no default program names are set, except for program 100, which will be called Single cycle.

Table 6.1: M720 Factory Default Values

Parameter	Description	Value
1	Drying method	TIME
3	Min. drying time	10 m
4	Max. drying time	45 m
5	Drying time	40 m
7	Dry temperature	167 °F / 75 °C
8	Offset sensor 2	2 °F / °C
9	Offset infrared	4 °F / °C
10	Humidity dry val.	15.00%
18	Cooldown time	10 m
19	Cooldown temp.	95 °F / 35 °C
23	Drum direction	REV
24	Drum speed	100.00%
25	Drum stop time	1 s
26	Drum run time	45 s
29	Anti crease funct.	YES
32	Max. temp. rise	0 °/m
33	Max. temp. fall	0 °/m

In the default programs, some parameter values are set to a different value to provide different programs to start with. The following default programs are available:

Table 6.2: M720 Factory Default Programs

<b>Program</b>	<b>Drying Time</b>	<b>Drying temperature</b>
1	40	167 °F / 75 °C
2	30	140 °F / 60 °C
3	30	113 °F / 45 °C
4	40	140 °F / 60 °C
5	25	122 °F / 50 °C
6	25	113 °F / 45 °C
7	25	104 °F / 40 °C
8	20	104 °F / 40 °C
9	0	n/a (only cool down)
10	50	194 °F / 90 °C
50	20	140 °F / 60 °C

Table 6.3: M720 Factory Default Machine Parameters

<b>Parameter</b>	<b>Description</b>	<b>Value</b>
1	Tmp in Fahrenheit	NO
5	Maintenance cycl	0
6	Finished beeptim.	5 s
7	Overview status	0
11	RS485 stationnr.	1
12	RS485 baudrate	0
16	Cnt.reset no pass	YES
26	Rotation time-out	10 s
27	Jog drum speed	25.00%
30	Heater reset time	3 s
31	Blower clean time	5 s
32	Blower WYE del.	10 s
33	Del. check airflow	10 s
40	Max. inlet temp.	302 °F / 150 °C